

ELEMENT G2

Constant Voltage – Non dimmable



Areas of application

- Decorative lighting in hospitality, restaurants and Shops
- Shelf lighting
- Cove lighting
- Under cabinet lighting

Product family benefits

- High efficiency (up to 91 %)
- Higher quality of light thanks to < 3% output ripple current
- Excellent price/performance ratio
- Class II design for wide application
- 3 years guarantee

Product family features

- Linear form factor
- Power factor: >0.95 at full load
- Total Harmonic Distortion (THD): < 15%
- Output voltage tolerance: < 3%
- Up to 30,000 h @ T_c max / up to 50,000 h @ T_c -10 °C
- Lifetime: up to 30,000 h (temperature at max. t_c)

Product family datasheet

Technical data

Electrical data

Product description	Nominal input voltage	Mains frequency	Input voltage AC	Power factor λ	ECG efficiency	Device power loss
ELEMENT 30/220-240/24 G2	220...240 V	50...60 Hz	198...264 V	0.95	86 %	4.9 W ¹⁾
ELEMENT 60/220-240/24 G2	220...240 V	50...60 Hz	198...264 V	0.95	88 %	8.2 W ¹⁾
ELEMENT 120/220-240/24 G2	220...240 V	50...60 Hz	198...264 V	0.95	89 %	14.8 W ¹⁾
ELEMENT 180/220-240/24 G2	220...240 V	50...60 Hz	198...264 V	0.90	91 %	17.8 W ¹⁾

Product description	Inrush current	Max. ECG no. on circuit breaker 10 A (C)	Max. ECG no. on circuit breaker 10 A (B)	Max. ECG no. on circuit breaker 16 A (C)	Max. ECG no. on circuit breaker 16 A (B)
ELEMENT 30/220-240/24 G2	< 16 A ²⁾	23	13	38	23
ELEMENT 60/220-240/24 G2	< 25 A ³⁾	16	10	26	15
ELEMENT 120/220-240/24 G2	< 32 A ⁴⁾	8	5	12	8
ELEMENT 180/220-240/24 G2	< 40 A ⁵⁾	5	3	9	5

Product description	Max. ECG no. on circuit breaker 25 A (B)	Surge capability (L-N)	Nominal output voltage	Nominal output power
ELEMENT 30/220-240/24 G2	35	1 kV	24 V	30 W
ELEMENT 60/220-240/24 G2	24	1 kV	24 V	60 W
ELEMENT 120/220-240/24 G2	12	1 kV	24 V	120 W
ELEMENT 180/220-240/24 G2	8	1 kV	24 V	180 W

Product description	Galvanic isolation primary/secondary	Output ripple Voltage (100 Hz)
ELEMENT 30/220-240/24 G2	3 kV	< 3 %
ELEMENT 60/220-240/24 G2	3 kV	< 3 %
ELEMENT 120/220-240/24 G2	3 kV	< 3 %
ELEMENT 180/220-240/24 G2	3 kV	< 3 %

¹⁾ At Full load, 230 V, 50 Hz

²⁾ At 240 μ s

³⁾ At 340 μ s

⁴⁾ At 520 μ s

⁵⁾ At 765 μ s

Product family datasheet

Dimensions & weight

Product description	Mounting hole spacing, length	Product weight	Cable cross-section, input side	Cable cross-section, output side	Wire preparation length, input side
ELEMENT 30/220-240/24 G2	137 mm	107.00 g	0.75...1.5 mm ²	0.75...1.5 mm ²	5.0 mm
ELEMENT 60/220-240/24 G2	192 mm	184.00 g	0.75...1.5 mm ²	0.75...1.5 mm ²	5.0 mm
ELEMENT 120/220-240/24 G2	252 mm	386.00 g	0.75...1.5 mm ²	0.75...1.5 mm ²	5.0 mm
ELEMENT 180/220-240/24 G2	292 mm	472.00 g	0.75...1.5 mm ²	0.75...1.5 mm ²	5.0 mm

Product description	Width	Height	Length
ELEMENT 30/220-240/24 G2	40.0 mm	26.5 mm	145.0 mm
ELEMENT 60/220-240/24 G2	40.0 mm	31.0 mm	200.0 mm
ELEMENT 120/220-240/24 G2	40.0 mm	31.0 mm	260.0 mm
ELEMENT 180/220-240/24 G2	40.0 mm	31.0 mm	300.0 mm

Product line drawing

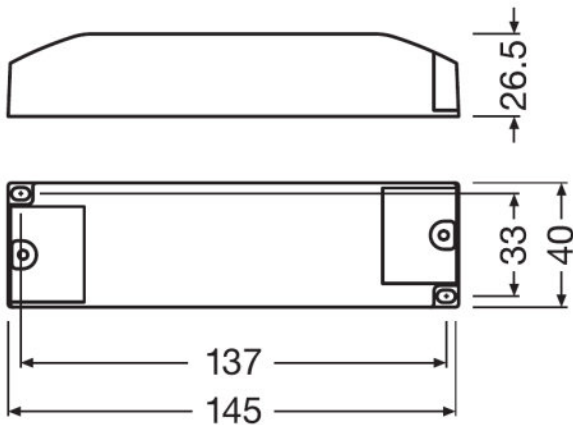

ELEMENT 30/220-240/24 G2

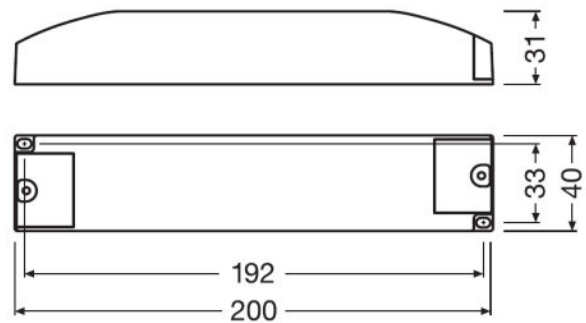

ELEMENT 60/220-240/24 G2

Product family datasheet

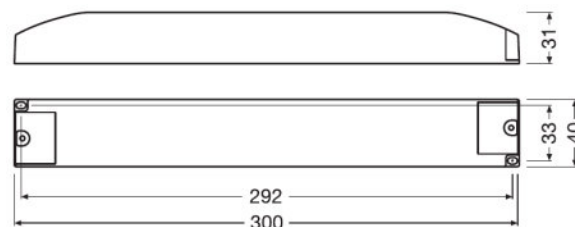
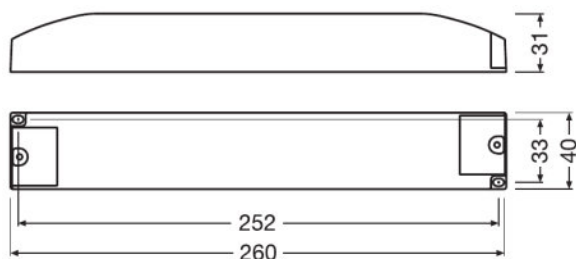

ELEMENT 120/220-240/24 G2

ELEMENT 180/220-240/24 G2

Colors & materials

Product description	Casing material
ELEMENT 30/220-240/24 G2	Plastic
ELEMENT 60/220-240/24 G2	Plastic
ELEMENT 120/220-240/24 G2	Plastic
ELEMENT 180/220-240/24 G2	Plastic

Temperatures & operating conditions

Product description	Ambient temperature range	Maximum temperature at tc test point	Max.housing temperature in case of fault	Temperature range at storage
ELEMENT 30/220-240/24 G2	-20...+50 °C	85 °C	110 °C	-40...+85 °C
ELEMENT 60/220-240/24 G2	-20...+50 °C	85 °C	110 °C	-40...+85 °C
ELEMENT 120/220-240/24 G2	-20...+50 °C	90 °C	110 °C	-40...+85 °C
ELEMENT 180/220-240/24 G2	-20...+50 °C	90 °C	110 °C	-40...+85 °C

Product description	Permitted rel. humidity during operation
ELEMENT 30/220-240/24 G2	5...85 % ¹⁾
ELEMENT 60/220-240/24 G2	5...85 % ¹⁾
ELEMENT 120/220-240/24 G2	5...85 % ¹⁾
ELEMENT 180/220-240/24 G2	5...85 % ¹⁾

¹⁾ Non-condensing

Product family datasheet

Lifespan

Product description	ECG lifetime
ELEMENT 30/220-240/24 G2	30000 h ¹⁾
ELEMENT 60/220-240/24 G2	30000 h ¹⁾
ELEMENT 120/220-240/24 G2	30000 h ¹⁾
ELEMENT 180/220-240/24 G2	30000 h ¹⁾

¹⁾ At maximum T_c / 10% failure rate

Additional product data

Product description	Encapsulated
ELEMENT 30/220-240/24 G2	No
ELEMENT 60/220-240/24 G2	Yes
ELEMENT 120/220-240/24 G2	Yes
ELEMENT 180/220-240/24 G2	Yes

Capabilities

Product description	Dimmable	Overheating protection	Overload protection
ELEMENT 30/220-240/24 G2	No	Yes	Yes
ELEMENT 60/220-240/24 G2	No	Yes	Yes
ELEMENT 120/220-240/24 G2	No	Yes	Yes
ELEMENT 180/220-240/24 G2	No	Yes	Yes

Product description	Short-circuit protection	Suitable for fixtures with prot. class	Number of channels
ELEMENT 30/220-240/24 G2	Yes	I / II	1
ELEMENT 60/220-240/24 G2	Yes	I / II	1
ELEMENT 120/220-240/24 G2	Yes	I / II	1
ELEMENT 180/220-240/24 G2	Yes	I / II	1

Certificates & standards

Product description	Approval marks – approval
ELEMENT 30/220-240/24 G2	CE / RCM / CCC / MM
ELEMENT 60/220-240/24 G2	CE / RCM / CCC / MM
ELEMENT 120/220-240/24 G2	CE / RCM / CCC / MM
ELEMENT 180/220-240/24 G2	CE / RCM / CCC / MM

Product description	Standards	Type of protection
ELEMENT 30/220-240/24 G2	Acc. to IEC 61347-1/Acc. to IEC 61347-2-13/Acc. to IEC 62384/Acc. to IEC 61000-3-2/Acc. to CISPR 15/Acc. to IEC 61000-3-3/Acc. to IEC 61547	IP20

Product family datasheet

Product description	Standards	Type of protection
ELEMENT 60/220-240/24 G2	Acc. to IEC 61347-1/Acc. to IEC 61347-2-13/Acc. to IEC 62384/Acc. to IEC 61000-3-2/Acc. to CISPR 15/Acc. to IEC 61000-3-3/Acc. to IEC 61547	IP20
ELEMENT 120/220-240/24 G2	Acc. to IEC 61347-1/Acc. to IEC 61347-2-13/Acc. to IEC 62384/Acc. to IEC 61000-3-2/Acc. to CISPR 15/Acc. to IEC 61000-3-3/Acc. to IEC 61547	IP20
ELEMENT 180/220-240/24 G2	Acc. to IEC 61347-1/Acc. to IEC 61347-2-13/Acc. to IEC 62384/Acc. to IEC 61000-3-2/Acc. to CISPR 15/Acc. to IEC 61000-3-3/Acc. to IEC 61547	IP20

Logistical data

Product description	Commodity code
ELEMENT 30/220-240/24 G2	850440829000
ELEMENT 60/220-240/24 G2	850440829000
ELEMENT 120/220-240/24 G2	850440829000
ELEMENT 180/220-240/24 G2	850440829000







Application advice

For more detailed application information and graphics please see product datasheet.

Sales and Technical Support

Sales and Technical Support www.osram.com

Download Data

File
 User instruction ELEMENT G2 Constant Voltage Power Supply
 Declarations of conformity ELEMENT 24V G2 CE 3427815 081119
 CAD data ELEMENT 30 24V G2 STEP 041219
 CAD data ELEMENT 30 24V G2 IGS 041219
 CAD data ELEMENT 60 24V G2 STEP 041219
 CAD data ELEMENT 60 24V G2 IGS 041219
 CAD data ELEMENT 120 24V G2 STEP 041219

Product family datasheet



CAD data
ELEMENT 120 24V G2 IGS 041219



CAD data
ELEMENT 180 24V G2 STEP 041219



CAD data
ELEMENT 180 24V G2 IGS 041219

Logistical Data

Product code	Product description	Packaging unit (Pieces/Unit)	Dimensions (length x width x height)	Volume	Gross weight
4052899605503	ELEMENT 30/220-240/24 G2	Shipping carton box 40	454 mm x 319 mm x 123 mm	17.81 dm ³	5090.00 g
4052899605527	ELEMENT 60/220-240/24 G2	Shipping carton box 30	454 mm x 219 mm x 164 mm	16.31 dm ³	6234.00 g
4052899605541	ELEMENT 120/220-240/24 G2	Shipping carton box 20	454 mm x 279 mm x 123 mm	15.58 dm ³	8470.00 g
4052899605565	ELEMENT 180/220-240/24 G2	Shipping carton box 20	454 mm x 319 mm x 123 mm	17.81 dm ³	10190.00 g

The mentioned product code describes the smallest quantity unit which can be ordered. One shipping unit can contain one or more single products. When placing an order, for the quantity please enter single or multiples of a shipping unit.

References / Links

For more information on the multi-level guarantee and the terms and conditions of the guarantee visit

▶ www.osram.com/system-guarantee

Disclaimer

Subject to change without notice. Errors and omission excepted. Always make sure to use the most recent release.