

CV Power supplies 24 V



Product family features

- Type of protection: IP20
- Wide operating temperature range: -20...+50 °C
- Lifetime: up to 50,000 h (temperature at max. t_c)

Product family benefits

- Installation in cold and hot environments
- Very stable output power
- High electrical reversible short-circuit, overload, overtemperature protection
- Independent installation possible

Areas of application

- Facades, public squares, cruise ships
- Signage
- Suitable for indoor and outdoor installations

Product family datasheet

Technical data

| Product description | Electrical data | | | | | |
|------------------------|-----------------------|-----------------|---------------------------|------------------|---------------------------|------------------------|
| | Nominal input voltage | Mains frequency | Input voltage AC | Input voltage DC | Total harmonic distortion | Power factor λ |
| OT SLIM 30/220-240/24 | 220...240 V | 50...60 Hz | 195.5...276 V | 176...250 V | < 5 % | > 0.95 |
| OT SLIM 60/220-240/24 | 220...240 V | 50...60 Hz | 195.5...276 V | 176...250 V | < 5 % | > 0.95 |
| OT SLIM 100/220-240/24 | 220...240 V | 50...60 Hz | 195.5...276 V | 176...250 V | < 5 % | > 0.95 |
| OT SLIM 160/220-240/24 | 220...240 V | 50...60 Hz | 195.5...276 V | 176...250 V | < 5 % | > 0.95 |
| OT SLIM 250/220-240/24 | 220...240 V | 50...60 Hz | 195.5...276 V | 176...250 V | < 5 % | > 0.95 |
| OT 6/200...240/24 CE | 200...240 V | 50...60 Hz | 180...264 V ⁴⁾ | | | 0.50 ⁵⁾ |
| OT 20/220...240/24 | 220...240 V | 50...60 Hz | 198...264 V ⁴⁾ | - | 150 % | 0.50 ⁵⁾ |

| Product description | Efficiency in full-load | Device power loss | Inrush current | Max. ECG no. on circuit breaker 10 A (C) | Max. ECG no. on circuit breaker 16 A (B) | Max. ECG no. on circuit breaker 16 A (C) |
|------------------------|-------------------------|----------------------|--------------------|--|--|--|
| OT SLIM 30/220-240/24 | 86 % ¹⁾ | 4.9 W | 30 A | 15 | 14 | 23 |
| OT SLIM 60/220-240/24 | 90 % ¹⁾ | 8.2 W | 40 A | 11 | 10 | 17 |
| OT SLIM 100/220-240/24 | 91 % ¹⁾ | 9.9 W | 50 A | 6 | 6 | 10 |
| OT SLIM 160/220-240/24 | 92 % ¹⁾ | 13.9 W | 60 A | | | 5 |
| OT SLIM 250/220-240/24 | 91 % ¹⁾ | 28 W | 70 A | | | |
| OT 6/200...240/24 CE | 80 % ¹⁾ | 1.5 W ⁶⁾ | 15 A ⁷⁾ | | 48 | |
| OT 20/220...240/24 | 83 % ¹⁾ | 4.0 W ¹³⁾ | 17 A | - | 42 | - |

| Product description | Max. ECG no. on circuit breaker 25 A (B) | Surge capability (L-N) | Nominal output voltage | U-OUT (working voltage) | Nominal output power |
|------------------------|--|------------------------|------------------------|-------------------------|----------------------|
| OT SLIM 30/220-240/24 | 22 | 1 kV | 24.2 V | 24 V | 30 W |
| OT SLIM 60/220-240/24 | 16 | 1 kV | 24.2 V | 24 V | 60 W |
| OT SLIM 100/220-240/24 | 10 | 1 kV | 24.2 V | 24 V | 100 W |
| OT SLIM 160/220-240/24 | 5 | 1 kV | 24.2 V | 24 V | 160 W |
| OT SLIM 250/220-240/24 | | 1 kV | 24.2 V | 24 V | 250 W |
| OT 6/200...240/24 CE | - | 1 kV | 24 V ⁸⁾ | 25 V | 6 W ⁹⁾ |
| OT 20/220...240/24 | - | 1 kV | 24 V ¹⁴⁾ | 24 V | 20 W ¹⁵⁾ |

| Product description | Maximum output power | Galvanic isolation | Output ripple Voltage (100 Hz) | Max. ECG no. on circuit breaker 10 A (B) | Galvanic isolation primary/secondary |
|-----------------------|----------------------|--------------------|--------------------------------|--|--------------------------------------|
| OT SLIM 30/220-240/24 | 30 W ²⁾ | SELV | ± 5 % | | |
| OT SLIM 60/220-240/24 | 60 W ²⁾ | SELV | ± 5 % | | |

Product family datasheet

| Product description | Maximum output power | Galvanic isolation | Output ripple Voltage (100 Hz) | Max. ECG no. on circuit breaker 10 A (B) | Galvanic isolation primary/secondary |
|------------------------|----------------------|--------------------|--------------------------------|--|--------------------------------------|
| OT SLIM 100/220-240/24 | 100 W ²⁾ | SELV | ± 5 % | | |
| OT SLIM 160/220-240/24 | 160 W ²⁾ | SELV | ± 5 % | | |
| OT SLIM 250/220-240/24 | 250 W ²⁾ | SELV | ± 5 % | | |
| OT 6/200...240/24 CE | 6 W ²⁾ | SELV | | 30 | 3 kV |
| OT 20/220...240/24 | 20 W ²⁾ | SELV | - | 23 | 3 kV |

| Product description | Surge capability (L/N-Ground) | Dimensions & weight | | | |
|------------------------|-------------------------------|-------------------------------|----------------|---------------------------------|----------------------------------|
| | | Mounting hole spacing, length | Product weight | Cable cross-section, input side | Cable cross-section, output side |
| OT SLIM 30/220-240/24 | | 222.0 mm | 120.00 g | 0.75...1.5 mm ² | 0.75...1.5 mm ² |
| OT SLIM 60/220-240/24 | | 290.0 mm | 170.00 g | 0.75...1.5 mm ² | 0.75...1.5 mm ² |
| OT SLIM 100/220-240/24 | | 326.0 mm | 220.00 g | 0.75...1.5 mm ² | 0.75...1.5 mm ² |
| OT SLIM 160/220-240/24 | | 356.0 mm | 285.00 g | 0.75...1.5 mm ² | 0.75...1.5 mm ² |
| OT SLIM 250/220-240/24 | | 295.0 mm | 880.00 g | 0.75...1.5 mm ² | 0.75...1.5 mm ² |
| OT 6/200...240/24 CE | | | 52.00 g | 1.0 mm ² | 1.0 mm ² |
| OT 20/220...240/24 | - | - | 108.00 g | 0.75...1.5 mm ² | 0.5...1.5 mm ² |

| Product description | Wire preparation length, input side | Wire preparation length, output side | Height | Width | Length |
|------------------------|-------------------------------------|--------------------------------------|---------|---------|----------|
| OT SLIM 30/220-240/24 | 5.0 mm | 5.0 mm | 17.5 mm | 30.0 mm | 270.0 mm |
| OT SLIM 60/220-240/24 | 5.0 mm | 5.0 mm | 17.5 mm | 30.0 mm | 338.0 mm |
| OT SLIM 100/220-240/24 | 5.0 mm | 5.0 mm | 18.5 mm | 30.0 mm | 374.0 mm |
| OT SLIM 160/220-240/24 | 5.0 mm | 5.0 mm | 21.5 mm | 30.0 mm | 404.0 mm |
| OT SLIM 250/220-240/24 | 5.0 mm | 5.0 mm | 31.0 mm | 60.0 mm | 343.0 mm |
| OT 6/200...240/24 CE | 10 mm | 10 mm | 22.0 mm | 50.0 mm | 51.0 mm |
| OT 20/220...240/24 | 10 mm | 10 mm | 35.0 mm | 50.0 mm | 109.0 mm |

| Product description | Cable/wire length, input side | Cable/wire length, output side | Colors & materials | Temperatures & operating conditions | |
|------------------------|-------------------------------|--------------------------------|--------------------|-------------------------------------|--------------------------------------|
| | | | Casing material | Ambient temperature range | Maximum temperature at tc test point |
| OT SLIM 30/220-240/24 | | | Plastic | -25...+45 °C | 75 °C |
| OT SLIM 60/220-240/24 | | | Plastic | -25...+45 °C | 70 °C |
| OT SLIM 100/220-240/24 | | | Plastic | -25...+45 °C | 80 °C |

Product family datasheet

| Product description | Cable/wire length, input side | Cable/wire length, output side | Colors & materials | Temperatures & operating conditions | |
|------------------------|-------------------------------|--------------------------------|--------------------|-------------------------------------|--------------------------------------|
| | | | Casing material | Ambient temperature range | Maximum temperature at tc test point |
| OT SLIM 160/220-240/24 | | | Plastic | -25...+45 °C | 75 °C |
| OT SLIM 250/220-240/24 | | | Plastic | -25...+45 °C | 80 °C |
| OT 6/200...240/24 CE | 185 mm | 135 mm | Plastic | -20...+50 °C | 70 °C |
| OT 20/220...240/24 | - | - | Plastic | -20...+50 °C | 70 °C |

| Product description | Max.housing temperature in case of fault | Temperature range at storage | Permitted rel. humidity during operation | Lifespan |
|------------------------|--|------------------------------|--|------------------------|
| | | | | ECG lifetime |
| OT SLIM 30/220-240/24 | 110 °C | -40...+85 °C | 5...85 % ³⁾ | 50000 h |
| OT SLIM 60/220-240/24 | 110 °C | -40...+85 °C | 5...85 % ³⁾ | 50000 h |
| OT SLIM 100/220-240/24 | 110 °C | -40...+85 °C | 5...85 % ³⁾ | 50000 h |
| OT SLIM 160/220-240/24 | 110 °C | -40...+85 °C | 5...85 % ³⁾ | 50000 h |
| OT SLIM 250/220-240/24 | 110 °C | -40...+85 °C | 5...85 % ³⁾ | 50000 h |
| OT 6/200...240/24 CE | 100 °C | -40...+85 °C | 5...85 % ³⁾ | 50000 h ¹⁰⁾ |
| OT 20/220...240/24 | 90 °C | -40...+85 °C | 5...85 % ³⁾ | 30000 h |

| Product description | Capabilities | | | Overload protection |
|------------------------|-------------------|-------------------|---------------|----------------------|
| | Dimmable | Dimming interface | Dimming range | |
| OT SLIM 30/220-240/24 | No | - | - | Automatic reversible |
| OT SLIM 60/220-240/24 | No | - | - | Automatic reversible |
| OT SLIM 100/220-240/24 | No | - | - | Automatic reversible |
| OT SLIM 160/220-240/24 | No | - | - | Automatic reversible |
| OT SLIM 250/220-240/24 | No | - | - | Automatic reversible |
| OT 6/200...240/24 CE | No ¹¹⁾ | - | - | Automatic reversible |
| OT 20/220...240/24 | No ¹¹⁾ | - | - | Automatic reversible |

| Product description | Short-circuit protection | No-load proof | Intended for no-load operation | Suitable for fixtures with prot. class |
|------------------------|--------------------------|---------------|--------------------------------|--|
| OT SLIM 30/220-240/24 | Automatic reversible | - | No | I / II |
| OT SLIM 60/220-240/24 | Automatic reversible | - | No | I / II |
| OT SLIM 100/220-240/24 | Automatic reversible | - | No | I / II |
| OT SLIM 160/220-240/24 | Automatic reversible | - | No | I / II |
| OT SLIM 250/220-240/24 | Automatic reversible | - | No | I / II |

Product family datasheet

| Product description | Short-circuit protection | No-load proof | Intended for no-load operation | Suitable for fixtures with prot. class |
|----------------------|--------------------------|---------------|--------------------------------|--|
| OT 6/200...240/24 CE | Automatic reversible | Yes | No | II |
| OT 20/220...240/24 | Automatic reversible | Yes | No | II |

| Product description | Type of connection, input side | Type of connection, output side | Overheating protection | Number of channels |
|------------------------|--------------------------------|---------------------------------|------------------------|--------------------|
| OT SLIM 30/220-240/24 | Screw terminal | Screw terminal | | |
| OT SLIM 60/220-240/24 | Screw terminal | Screw terminal | | |
| OT SLIM 100/220-240/24 | Screw terminal | Screw terminal | | |
| OT SLIM 160/220-240/24 | Screw terminal | Screw terminal | | |
| OT SLIM 250/220-240/24 | Screw terminal | Screw terminal | | |
| OT 6/200...240/24 CE | | | Automatic reversible | |
| OT 20/220...240/24 | | Screw terminal | Automatic reversible | 1 |

| Product description | Certificates & standards | | | |
|------------------------|--|---|------------------|--------------------|
| | Approval marks – approval | Standards | Protection class | Type of protection |
| OT SLIM 30/220-240/24 | CE / CB / ENEC / CCC / EAC / RCM / BIS | Acc. to IEC 61347-2-13/Acc. to IEC 62384/Acc. to EN 55015/Acc. to IEC 61000-3-2/Acc. to IEC 61000-3-3 | II | IP20 |
| OT SLIM 60/220-240/24 | CE / CB / ENEC / CCC / EAC / RCM / BIS | Acc. to IEC 61347-2-13/Acc. to IEC 62384/Acc. to EN 55015/Acc. to IEC 61000-3-2/Acc. to IEC 61000-3-3 | II | IP20 |
| OT SLIM 100/220-240/24 | CE / CB / ENEC / CCC / EAC / RCM / BIS | Acc. to IEC 61347-2-13/Acc. to IEC 62384/Acc. to EN 55015/Acc. to IEC 61000-3-2/Acc. to IEC 61000-3-3 | II | IP20 |
| OT SLIM 160/220-240/24 | CE / CB / ENEC / CCC / EAC / RCM / BIS | Acc. to IEC 61347-2-13/Acc. to IEC 62384/Acc. to EN 55015/Acc. to IEC 61000-3-2/Acc. to IEC 61000-3-3 | II | IP20 |
| OT SLIM 250/220-240/24 | CE / CB / ENEC / CCC / EAC / RCM / BIS | Acc. to IEC 61347-2-13/Acc. to IEC 62384/Acc. to EN 55015/Acc. to IEC 61000-3-2/Acc. to IEC 61000-3-3 | II | IP20 |

Product family datasheet

| Product description | Certificates & standards | | | |
|----------------------|------------------------------------|--|------------------|--------------------|
| | Approval marks – approval | Standards | Protection class | Type of protection |
| OT 6/200...240/24 CE | CE / VDE / ENEC 10 / CB | Acc. to IEC 61347-2-13/Acc. to IEC 62384/Acc. to EN 55015/Acc. to IEC 61000-3-2/Acc. to IEC 61000-3-3/Acc. to IEC 61547 ¹²⁾ | II | IP65 |
| OT 20/220...240/24 | CE / ENEC 10 / VDE / VDE-EMC / RCM | Acc. to IEC 61347-2-13/Acc. to IEC 62384/Acc. to EN 55015/Acc. to IEC 61000-3-2/Acc. to IEC 61000-3-3/Acc. to IEC 61547 | II | IP20 |

| Product description | Logistical data |
|------------------------|-----------------|
| | Commodity code |
| OT SLIM 30/220-240/24 | 850440829000 |
| OT SLIM 60/220-240/24 | 850440829000 |
| OT SLIM 100/220-240/24 | 850440829000 |
| OT SLIM 160/220-240/24 | 850440829000 |
| OT SLIM 250/220-240/24 | 850440829000 |
| OT 6/200...240/24 CE | 850440829000 |
| OT 20/220...240/24 | 850440829000 |

1) at 230 V, 50 Hz

2) at steady state

3) Maximum 56 days/year at 85 %

4) Permitted voltage range

5) Minimum

6) Maximum at 230 V_{AC}, P_{out} = maximum, T_a=25 °C, steady state

7) At 240 V_{AC}

8) ±0.8 V

9) Partial load 0.9...6 W

10) At T_{case} = 60°C at T_c point / 10% failure rate

11) With OPTOTRONIC dimmers

12) Secondary switching not allowed

13) Maximum

14) ±1.0 V

15) Partial load 0.5...20 W

Product family datasheet

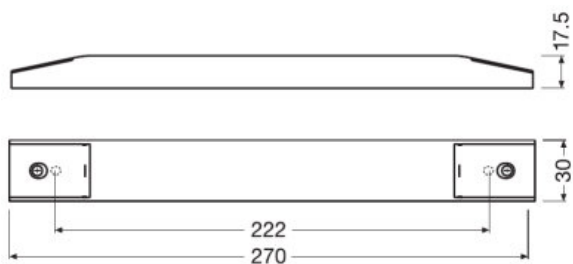

OT SLIM 30

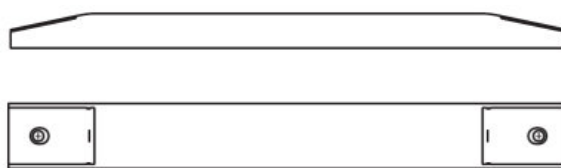

OT SLIM 30

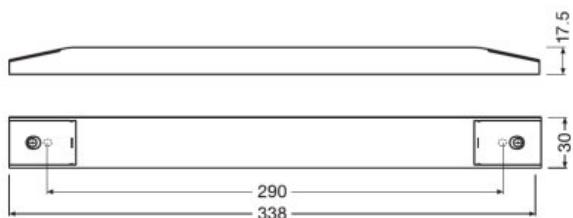

OT SLIM 60

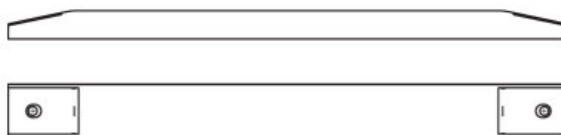

OT SLIM 60

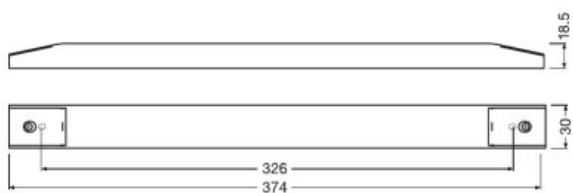

OT SLIM 100

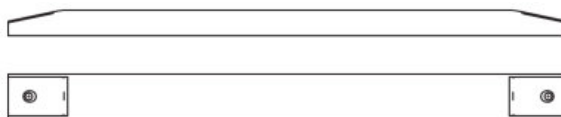

OT SLIM 100

Product family datasheet

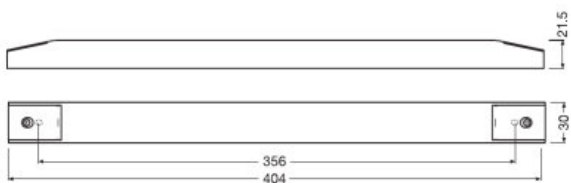

OT SLIM 160



OT SLIM 160

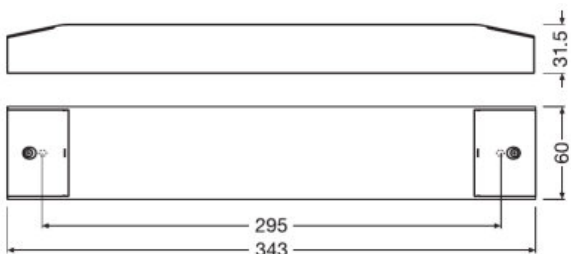

OT SLIM 250

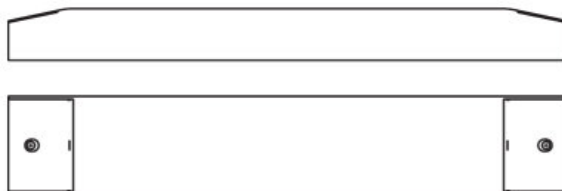

OT SLIM 250

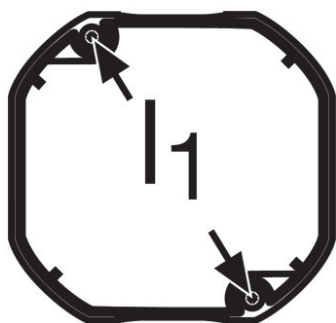

330712_OPROTRONIC OT 6200-24010

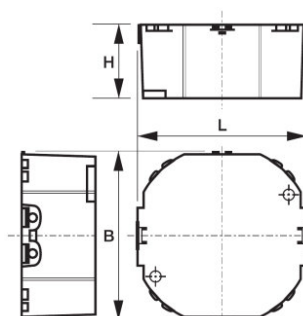

323601_OPTOTRONIC OT 6200-24010

Product family datasheet

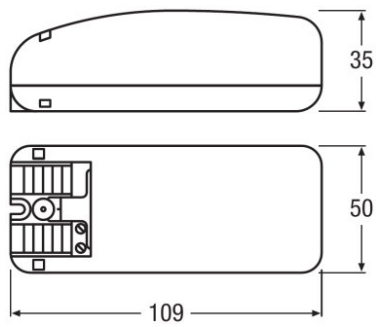

340540_OT 20220-24024

Application advice

For more detailed application information and graphics please see product datasheet.

Additional product information

- EMI pass verified with wire length of 2 m, from the ECG to the LED module at full load.
- Wiring longer than 2 m from ECG to LED module is possible, but site installation conditions may interfere with EMI with these longer cables. EMI is therefore not verified in this condition.
- For wires longer than 2 m, the appropriate cable cross section must be carefully selected to reduce voltage drop.

Sales and Technical Support

Sales and Technical Support www.osram.com



Country specific information

| Product description | Product code | METEL code | SEG-No. | STK number | UK Org |
|-------------------------|---------------|------------|---------|------------|--------|
| OT 6/200...240/24 CE | 4008321113269 | OSROT624CE | - | 4031154 | - |
| OT 6/200...240/24 CE | 4008321113269 | OSROT624CE | - | 4031154 | - |
| OT 20/220...240/24 | 4050300618111 | OSROT2024 | - | 4031160 | - |
| OT 20/220...240/24 | 4050300618111 | OSROT2024 | - | 4031160 | - |







Download Data

File

Product family datasheet

| | |
|---|---|
|  | User instruction OT SLIM |
|  | Product Datasheet OT SLIM 30220-24024 Technical Datasheet (EN) |
|  | Declarations of conformity OT SLIM 30 60 CE 4200563 110320 |
|  | CAD data OT SLIM 30 STEP 290420 |
|  | Product Datasheet OT SLIM 60 220-240 24 Technical Datasheet (EN) |
|  | CAD data OT SLIM 60 STEP 290420 |
|  | Product Datasheet OT SLIM 100 220-240 24 Technical Datasheet (EN) |
|  | Declarations of conformity OT SLIM 100 160 250 CE 4205404 310320 |
|  | CAD data OT SLIM 100 STEP 290420 |
|  | Product Datasheet OT SLIM 160 220-240 24 Technical Datasheet (EN) |
|  | CAD data OT SLIM 160 STEP 290420 |
|  | Product Datasheet OT SLIM 250 220-240 24 Technical Datasheet (EN) |
|  | Certificates OT SLIM RCM NSW28298 280720 |
|  | CAD data PDF OT SLIM 250 STEP 290420 |
|  | User instruction OPTOTRONIC CONSTANT VOLTAGE |
|  | Addon Technical Information 313236_ADDON TECHNICAL INFO OT 6200-24010 CE VS20 and OT 6200-24024 CE VS20 (GB) |
|  | Brochures OPTOTRONIC constant-voltage LED power supplies and controls (EN) |
|  | Brochures 730792_Light is universal - Easy installation of efficient complete systems (DE) |
|  | Brochures 730791_Light is universal - Easy installation of efficient complete systems (EN) |
|  | Certificates OT ENEC 40038447 210721 |
|  | Declarations of conformity 334859_Declaration of conformity – OT 6200-24010 CE |
|  | Declarations of conformity EU Declaration of Conformity 3578669 |
|  | CAD data 3-dim 313445_51x52x22 9900045 |

Product family datasheet

| | |
|---|--|
|  | CAD data 3-dim 313473_51x52x22 9900045 |
|  | CAD data PDF 313405_51x52x22 9900045 |
|  | User instruction OPTOTRONIC LED Power Supply |
|  | Addon Technical Information 313233_ADDON TECHNICAL INFORMATION OT 20230-24024 VS20 OSRAM (GB) |
|  | Declarations of conformity 334871_Declaration of conformity – OT 20220-24024 |
|  | CAD data 3-dim OT 20 220-240 24V Indoor-3D stp file |

Ecodesign regulation information:

Intended for use with LED modules.

The forward voltage of the LED light source shall be within the defined operating window of the control gear in all operating conditions including dimming if applicable.

Separate control gear and light sources must be disposed of at certified disposal companies in accordance with Directive 2012/19/EU (WEEE) in the EU and with Waste Electrical and Electronic Equipment (WEEE) Regulations 2013 in the UK. For this purpose, collection points for recycling centres and take-back systems (CRSO) are available from retailers or private disposal companies, which accept separate control gear and light sources free of charge. In this way, raw materials are conserved and materials are recycled.

Logistical Data

| Product code | Product description | Packaging unit (Pieces/Unit) | Dimensions (length x width x height) | Volume | Gross weight |
|---------------|------------------------|------------------------------|--------------------------------------|-----------------------|--------------|
| 4062172135733 | OT SLIM 30/220-240/24 | Shipping carton box 50 | 315 mm x 282 mm x 145 mm | 12.88 dm ³ | 6453.00 g |
| 4062172135856 | OT SLIM 60/220-240/24 | Shipping carton box 30 | 350 mm x 192 mm x 145 mm | 9.74 dm ³ | 5560.00 g |
| 4062172135870 | OT SLIM 100/220-240/24 | Shipping carton box 30 | 387 mm x 192 mm x 150 mm | 11.15 dm ³ | 7058.00 g |
| 4062172135894 | OT SLIM 160/220-240/24 | Shipping carton box 30 | 417 mm x 192 mm x 165 mm | 13.21 dm ³ | 8996.00 g |
| 4062172135917 | OT SLIM 250/220-240/24 | Shipping carton box 10 | 357 mm x 312 mm x 100 mm | 11.14 dm ³ | 9236.00 g |
| 4008321113269 | OT 6/200...240/24 CE | Shipping carton box 20 | 328 mm x 76 mm x 138 mm | 3.44 dm ³ | 1212.50 g |
| 4050300618111 | OT 20/220...240/24 | Shipping carton box 20 | 270 mm x 105 mm x 229 mm | 6.49 dm ³ | 2396.00 g |

Product family datasheet

Logistical Data

The mentioned product code describes the smallest quantity unit which can be ordered. One shipping unit can contain one or more single products. When placing an order, for the quantity please enter single or multiples of a shipping unit.

Disclaimer

Subject to change without notice. Errors and omission excepted. Always make sure to use the most recent release.